

## Systems IN STOCK

Full-featured,  
contract-quality  
systems furniture  
backed by a limited  
lifetime warranty.

- Recyclable metal materials
- Powdercoat finishes
- Re-usable metal-to-metal connections
- Glass panels with real glass
- Strong core construction
- Meets ANSI/BIFMA
- UL approved, including electrical and fabric
- 100% polyester UL-recognized (UR) fabric
- Installer-friendly, rod-and-block assembly
- IN STOCK





**Systems IN STOCK** electrical is designed specifically for the system and is both UL Listed and CSA Certified. It is an 8-wire, 4-circuit system with 3 open, 1 dedicated circuit to support any power/data requirements. Power can run through panels and connectors. Ceiling and base feeds are available. The flush-design, black raceways feature steel bases, scratch-resistant resin covers and adjustable glides.

### Worksurfaces

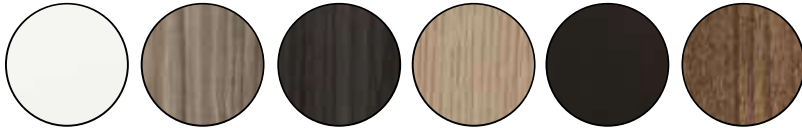

**WHT**  
White

**URB**  
Urban Walnut

**SGW**  
Slate Grey

**NAS**  
Natty Ash

**ESP**  
Espresso

**PCW**  
Park City  
In Stock: NJ

### Fabric



**01**  
Drift

### Finishes

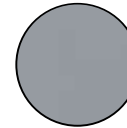

**SV**  
Silver

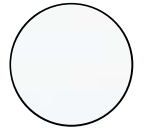

**WH**  
White



**Telemarketing Station**  
**2-Pack 8' x 2.5'**  
Silver finish & Espresso  
worksurfaces  
67"H Panels with Locking  
Overheads  
LED Lighting  
Mobile Pedestals



### A. Panels - Fabric

67H x 24W	53H x 24W	39H x 24W
67H x 30W	53H x 30W	39H x 30W
67H x 36W	53H x 36W	39H x 36W
67H x 42W	53H x 42W	39H x 42W
67H x 48W	53H x 48W	39H x 48W

### B. Panels - Fabric + Glass

67H x 24W	53H x 24W
67H x 30W	53H x 30W
67H x 36W	53H x 36W
67H x 42W	53H x 42W
67H x 48W	53H x 48W

\*\* White panels available with Black or White raceways

\*\* Raceway covers, end caps and draw rods specified separately

\*\* Non-powered and powered panels available

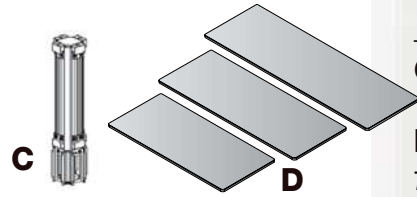

### C. Connectors - 67, 53 & 39 Heights

2-way 3-Way 4-Way

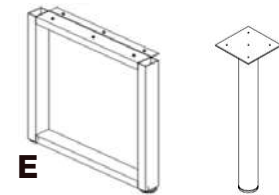

### D. Worksurfaces

72W x 24D	72W x 30D
66W x 24D	66W x 30D (NJ Only)
60W x 24D	60W x 30D
48W x 24D	48W x 30D
42W x 24D	72W x 30D Bullet (NJ Only)
36W x 24D	36W x 36D Corner
30W x 24D	42W x 42D Corner
24W x 24D	

### Transaction Counters

72W x 14D
60W x 14D

### Transaction Counter Brackets

End Bracket
Middle Bracket
Panel/Connector Bracket

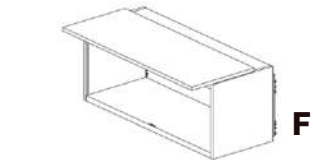

### E. Worksurface Support Legs

24"D O-Leg	Single Peninsula Leg
30"D O-Leg	

A full selection of panel-hung, worksurface supporting Hardware is available

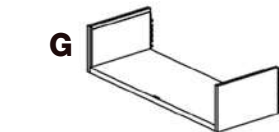

### F. Metal Overhead Storage with Flipper Door

24", 30", 36", 42" & 48" widths

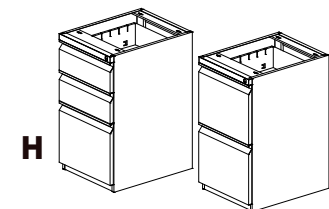

### G. Metal Hanging Shelf

24", 30", 36", 42" & 48" widths

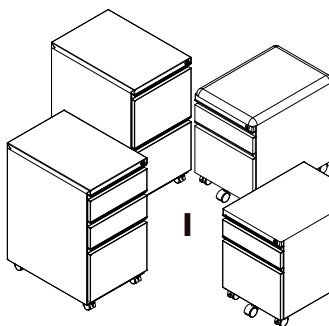

### H. Worksurface Supporting Pedestals (Open Top)

Box/Box/File File/File



### I. Mobile Pedestals (Closed Top)

Box/Box/File	File/File	Box/File	Box/File
w/Casters	w/Casters	w/Cushion+Casters	w/Casters



### J. Task Lighting

24"W LED Task Light (connectable)  
24"W Motion LED Task Light (connectable)  
\*\* Motion sensor for auto on/off...power savings

### K. Clear & Frosted Glass 14"H

Mount on Top of Panel  
Clear Glass: 24"W, 30"W, 36"W, 42"W & 48"W  
Frosted Glass: 24"W, 30"W, 36"W, 42"W & 48"W

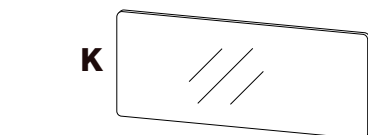

### L. Fabric Tackboards 11.5"H

24", 30", 36", 42" & 48" widths

### M. Power Chargers

#### Undersurface Mount (left):

Includes: USB Type-C, USB Type-A & (3) A/C plugs

#### Clamp-Mount (right):

Includes: USB Type-C, USB Type-A & (3) A/C plugs  
Fits 1/2" - 1 1/2" surfaces

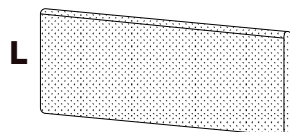

# Systems IN STOCK



*Silver Finish  
& White Worksurfaces*

Complete UL approved 8-wire, 4-circuit electrical system also in stock  
Panels can be shipped non-powered or powered

**SISTYP303-S1W**  
3-Pack 6x6x39H



*White Finish  
& White Worksurfaces*

**SISTYP602-W1W**  
6-Pack 5x5x53H



*Silver Finish  
& White Worksurfaces*

**SISTYP301-S1W**  
3-Pack 6x6x67H and 53H



*White Finish, Black Raceways &  
Slate Grey Worksurfaces*

**SISTYP303GC-W1S**  
3-Pack 6x6x39H with Clear Glass



*White Finish, White Raceways &  
Slate Grey Worksurfaces*

**SISTYP303G-WW1S**  
3-Pack 6x6x39H with Frosted Glass



**Telemarketing Station 2-Pack**  
**8' x 2.5'**

Silver finish & Espresso worksurfaces  
67" H Panels with Overheads  
LED Lighting  
Mobile Pedestals







**OSP ASCEND II™**  
**Electric Base**  
see page 75

**PHAT**  
**Pneumatic Base**  
see page 83-85

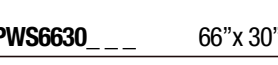
**Training Table**  
**Flip-Top Base**  
see page 86

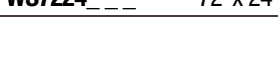
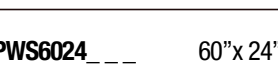
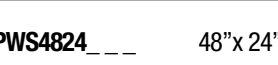
**Pace T-Arc Legs**  
see page 92

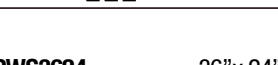
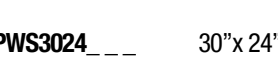
**Rectangular Worksurfaces**

	<b>PWS7230</b> ___	72"x 30"	<b>\$625</b>	A2EB322, A2EB333 A2EB222	HB6026	n/a	2 qty PAC-LEGTARC + 2 qty PAC-SB6
	<b>PWS6630</b> ___	66"x 30"	<b>\$600</b>	A2EB322, A2EB333 A2EB222	HB6025	n/a	2 qty PAC-LEGTARC + 2 qty PAC-SB5
	<b>PWS6030</b> ___	60"x 30"	<b>\$525</b>	A2EB322, A2EB333 A2EB222	HB6025	n/a	2 qty PAC-LEGTARC + 2 qty PAC-SB5
	<b>PWS4830</b> ___	48"x 30"	<b>\$430</b>	A2EB322, A2EB333 A2EB222	HB6024	n/a	2 qty PAC-LEGTARC + 2 qty PAC-SB4
	<b>PWS7224</b> ___	72"x 24"	<b>\$500</b>	A2EB322, A2EB333, A2EB222	HB6026	842FM6	2 qty PAC-LEGTARC + 1 qty PAC-SB6
	<b>PWS6624</b> ___	66"x 24"	<b>\$475</b>	A2EB322, A2EB333, A2EB222	HB6025	842FM5	2 qty PAC-LEGTARC + 1 qty PAC-SB5
	<b>PWS6024</b> ___	60"x 24"	<b>\$435</b>	A2EB322, A2EB333, A2EB222	HB6025	842FM5	2 qty PAC-LEGTARC + 1 qty PAC-SB5
	<b>PWS4824</b> ___	48"x 24"	<b>\$350</b>	A2EB322, A2EB333, A2EB222	HB6024	842FM4	2 qty PAC-LEGTARC + 1 qty PAC-SB4
	<b>PWS4224</b> ___	42"x 24"	<b>\$320</b>	A2EB333	n/a		2 qty PAC-LEGTARC
	<b>PWS3624</b> ___	36"x 24"	<b>\$290</b>	A2EB333	n/a		2 qty PAC-LEGTARC
	<b>PWS3024</b> ___	30"x 24"	<b>\$275</b>	A2EB333	n/a		2 qty PAC-LEGTARC
	<b>PWS2424</b> ___	24"x 24"	<b>2-pack</b> <b>\$430</b>	n/a	n/a		2 qty PAC-LEGTARC

**Corner & Bullet Worksurfaces & Transaction Counters**

	<b>PWS36CNR</b> ___	36"x 36" Corner	<b>\$475</b>	A2EB333	n/a	n/a	n/a
	<b>PWS42CNR</b> ___	42"x 42" Corner	<b>\$585</b>	A2EB333	n/a	n/a	n/a
	<b>PWS7230BU</b> ___	72"x 30" Bullet	<b>\$700</b>	A2EB322, A2EB333, A2EB222	HB6026	n/a	2 qty PAC-LEGTARC + 2 qty PAC-SB6
	<b>PWS7214</b> ___	72"x 14" Transaction Counter	<b>\$300</b>	n/a	n/a	n/a	n/a
	<b>PWS6014</b> ___	60"x 14" Transaction Counter	<b>\$285</b>	n/a	n/a	n/a	n/a

**Systems IN STOCK** Worksurfaces are not pre-drilled for attachment of any of the above bases. No hardware is included. Tops are 1" thick. Ganging hardware included on 842 Series Tops is not included on Systems worksurfaces (PWS models). Systems discount applies to all PWS models. Bases shown are Casegoods discount, except Systems Support Legs.



**Pace Post Legs**  
see page 92

**Black Metal Bases**  
see page 63

4 qty PAC-LEGPOST + 2 qty PAC-SB6	2 qty NAP-33B (28.5"H) 2 qty NAP-32B (41"H)
4 qty PAC-LEGPOST + 2 qty PAC-SB5	2 qty NAP-33B (28.5"H) 2 qty NAP-32B (41"H)
4 qty PAC-LEGPOST + 2 qty PAC-SB5	2 qty NAP-33B (28.5"H) 2 qty NAP-32B (41"H)
4 qty PAC-LEGPOST + 2 qty PAC-SB4	n/a

4 qty PAC-LEGPOST + 1 qty PAC-SB6	n/a
--------------------------------------	-----

4 qty PAC-LEGPOST + 1 qty PAC-SB5	n/a
--------------------------------------	-----

4 qty PAC-LEGPOST + 1 qty PAC-SB5	n/a
--------------------------------------	-----

4 qty PAC-LEGPOST + 1 qty PAC-SB4	n/a
--------------------------------------	-----

4 qty PAC-LEGPOST	n/a
-------------------	-----

4 qty PAC-LEGPOST	n/a
-------------------	-----

4 qty PAC-LEGPOST	n/a
-------------------	-----

4 qty PAC-LEGPOST	n/a
-------------------	-----

n/a	n/a
-----	-----

n/a	n/a
-----	-----

4 qty PAC-LEGPOST + 2 qty PAC-SB6	2 qty NAP-33B (28.5"H) 2 qty NAP-32B (41"H)
--------------------------------------	------------------------------------------------

n/a	n/a
-----	-----

n/a	n/a
-----	-----

**OSP Ascend II™ Electric Bases**



**PHAT Pneumatic Bases**



**Training Table Nesting/Flip-Top Bases**



**Pace T-Arc Legs**



**Pace Post Legs**



**Black Metal Base**



**Systems Support Legs**



**PH-SPEN24**  
3" diameter  
Support Leg  
\$195

**PH-OLEG24**  
24"D O-Leg  
\$365

**PH-OLEG30**  
30"D O-Leg  
\$440



**OYF222-WT**  
Dual-Motor / 2-Stage Height Adjustable Base,  
White **\$1,000**  
Shown with 60"W x 30"D Natty Ash Top **\$525**  
More sizes & colors available; see page 28

**On Your Feet!**

A new high-value, dual-motor/2-stage sit/stand base pairs with the PWS Series tops (see page 28) for extensive size options in our best-selling laminate colors.

**Base Colors**



**BK**  
Black

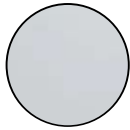

**SL**  
Silver

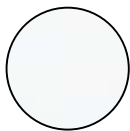

**WT**  
White

**FEATURES**

- Multiple memory presets
- Width-adjustable to support 48" -72" wide tops
- Supports 24"-30" deep tops
- Weight capacity 220 lbs. (including top)
- Adjusts 27.5" to 46.75" high
- Moves 25 mm/s
- Less than 50 dB
- 200 lbs. weight capacity (evenly distributed, top included)
- White, silver & black finishes

**PWS Series**

See page 28 for top sizes/prices



**URB**  
Urban Walnut

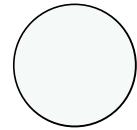

**WHT**  
White



**SGW**  
Slate Grey



**NAS**  
Natty Ash



**ESP**  
Espresso  
NJ Only



**PCW**  
Park City  
NJ Only



**OYF222-WT** | **PWS6030-SGW**  
Base, White | Top, Slate Grey (see page 28)



Adjusts 27.5" to 46.75"H  
Width-adjustable to support 48"-72"W tops



## New Soft-Close Nesting Table

- Supports 24"-30" deep tops
- T-base design allows users on both sides of table
- Base adjusts 43"-55" wide for various top widths
- Black or Silver
- Stylish foot design and round columns
- Pair with PWS Series tops (see page 28)



**SFT4530-SV**  
Soft-Close Flip-Top Table Base, Silver  
**\$1,325**  
Shown with 60"W x 30"D Slate Grey Top **\$525**



**SFT4530-B**  
Soft-Close Flip-Top Table Base, Black  
**\$1,325**  
Shown with 60"W x 30"D Natty Ash Top **\$525**

*Soft-Close base features 200 lbs. weight capacity (evenly distributed, top included)*



*Single-lever, dual-cable actuator for securing top.*

## Make the most of every meeting anywhere in the office!

Introducing a glassboard with so much more:

- Mobile
- Write/erase side ... also magnetic
- Tackable side
- Large 40"Wx72"H usable area

### MMGB4072-B

#### Mobile Magnetic Glassboard

White tempered glass

Markers, eraser and magnetic holder included

Color magnets included

Tackable Grey PET Felt on reverse side

Black metal feet and edges

Locking casters

40"W x 24"D x 72"H

**\$2,750**



*Grey PET Felt is both tackable and acoustical, performing two functions at the same time!*



# Modern. Modular. Multipurpose.

ENGAGE™ desking combines clean, open-leg style with modular components that can be configured in both freestanding and build-to-length configurations. Primary and Add-On frames in 4', 5' & 6' widths are triple-rigid with metal legs, metal channel and metal cross-member supports. All support 24" and 30" deep worksurfaces. Tackable/Acoustical divider screens slide over tubular metal posts for superior rigidity.

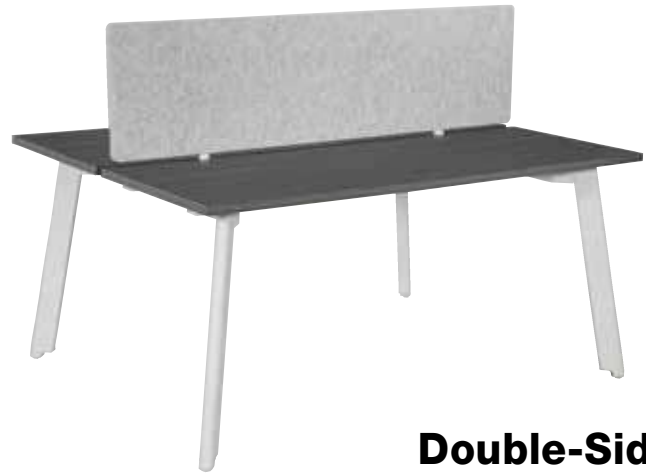

## Double-Sided

ENGAGE™ excels in collaborative environments and multi-user areas as well as popular touchdown and hoteling applications. Double-sided units combine one frame and two worksurfaces with area between for wire management as well as attachment of divider screen hardware. Tackable/acoustical divider screens recommended.



## Single-Sided

ENGAGE™ features a low-profile center channel that doubles as a wire-management trough and conceals wires and/or electrical system from view. Single-sided units, comprised of one frame and one worksurface, provide flexibility for a variety of applications. Add tackable/acoustical divider screens in 4 color options as well as monitor arms and power modules.

## Versatile

Designed with primary + add-on modularity, ENGAGE™ provides optimum flexibility and dollar-saving practicality. With modern silver and white finishes and 4 matching commercial-grade laminate worksurface finishes, ENGAGE™ can be combined with other wood/laminate casegoods, such as Napa Series in Urban Walnut as shown below.



**Casegoods IN STOCK**



## Double-Sided | Collaborative Spaces

Build-to-length, double-sided ENGAGE™ configurations create collaborative opportunities in clean, contemporary style. The low-profile center channel is designed to carry power/data to all users. Add tackable/acoustical divider screens for enhanced convenience. Combine with Office Star pedestals, lateral files, power modules, monitor arms and seating for a full-function office environment.

24D TOPS	2-persons	+ Screen	4-persons	+ Screen	6-persons	+ Screen
4'	\$1,940	\$2,405	\$3,430	\$4,360	\$4,920	\$6,315
5'	\$2,175	\$2,720	\$3,975	\$5,065	\$5,775	\$7,410
6'	\$2,390	\$2,985	\$4,380	\$5,570	\$6,370	\$8,155

30D TOPS	2-persons	+ Screen	4-persons	+ Screen	6-persons	+ Screen
4'	\$2,110	\$2,575	\$3,770	\$4,700	\$5,430	\$6,825
5'	\$2,375	\$2,920	\$4,375	\$5,465	\$6,375	\$8,010
6'	\$2,650	\$3,245	\$4,900	\$6,090	\$7,150	\$8,935



### Single-Sided | Space-Efficient

Whether freestanding in open space or along a wall, single-sided ENGAGE™ configuration provide flexibility to maximize every square foot of your office space. Both 24” and 30” deep worksurfaces are supported by the same frame, allowing flexibility both today and in the future. Worksurfaces and frames are available to create 4’, 5’ and 6’ wide units.

24D TOPS	1-person	+ Screen	2-persons	+ Screen	3-persons	+ Screen
4'	\$1,320	\$1,785	\$2,290	\$3,220	\$3,260	\$4,655
5'	\$1,425	\$1,970	\$2,500	\$3,590	\$3,575	\$5,210
6'	\$1,520	\$2,115	\$2,690	\$3,880	\$3,860	\$5,645

30D TOPS	1-person	+ Screen	2-persons	+ Screen	3-persons	+ Screen
4'	\$1,405	\$1,870	\$2,460	\$3,390	\$3,515	\$4,910
5'	\$1,525	\$2,070	\$2,700	\$3,790	\$3,875	\$5,510
6'	\$1,650	\$2,245	\$2,690	\$4,140	\$4,250	\$6,035

**Single Frame**

CMB1PP2448	48x24 Primary Frame	\$975
CMB1PP2460	60x24 Primary Frame	\$1,000
CMB1PP2472	72x24 Primary Frame	\$1,025



**Single Add-On**

CMB1PE2448	48x24 Add-On	\$625
CMB1PE2460	60x24 Add-On	\$650
CMB1PE2472	72x24 Add-On	\$675



**Tackable/Acoustical Divider Screen (Single)**

CMBDSHWKS__	Screen Hardware Kit - Single	\$70
CMBDS48	48W Tackable Divider Screen	\$395
CMBDS60	60W Tackable Divider Screen	\$475
CMBDS72	72W Tackable Divider Screen	\$525



**Double Frame**

CMB2PP4848	48x24 Primary Frame	\$1,250
CMB2PP4860	60x24 Primary Frame	\$1,325
CMB2PP4872	72x24 Primary Frame	\$1,400



**Double Add-On**

CMB2PE4848	48x24 Add-On	\$800
CMB2PE4860	60x24 Add-On	\$950
CMB2PE4872	72x24 Add-On	\$1,000



**Tackable/Acoustical Divider Screen (Double)**

CMBDSHWKD__	Screen Hardware Kit - Double	\$50
CMBDS48	48W Tackable Divider Screen	\$395
CMBDS60	60W Tackable Divider Screen	\$475
CMBDS72	72W Tackable Divider Screen	\$525



**Worksurfaces 24"D**

PWS4824	48x24 Worksurface	\$345
PWS6024	60x24 Worksurface	\$425
PWS7224	72x24 Worksurface	\$495

**Worksurfaces 30"D**

PWS4830	48x30 Worksurface	\$430
PWS6030	60x30 Worksurface	\$525
PWS7230	72x30 Worksurface	\$625

**Metal Frame Finishes**



**MS**  
Silver

**WD**  
White

**Laminate Top Colors**



**URB**  
Urban Walnut

**SGW**  
Slate Grey



**WHT**  
White

**ESP**  
Espresso  
*NJ Only*



**PCW**  
Park City  
*NJ Only*

**Tackable/Acoustical Divider Screen Colors**

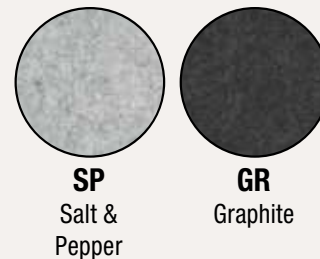

**SP**  
Salt & Pepper

**GR**  
Graphite



**EB**  
Ebony

**CS**  
Cashmere

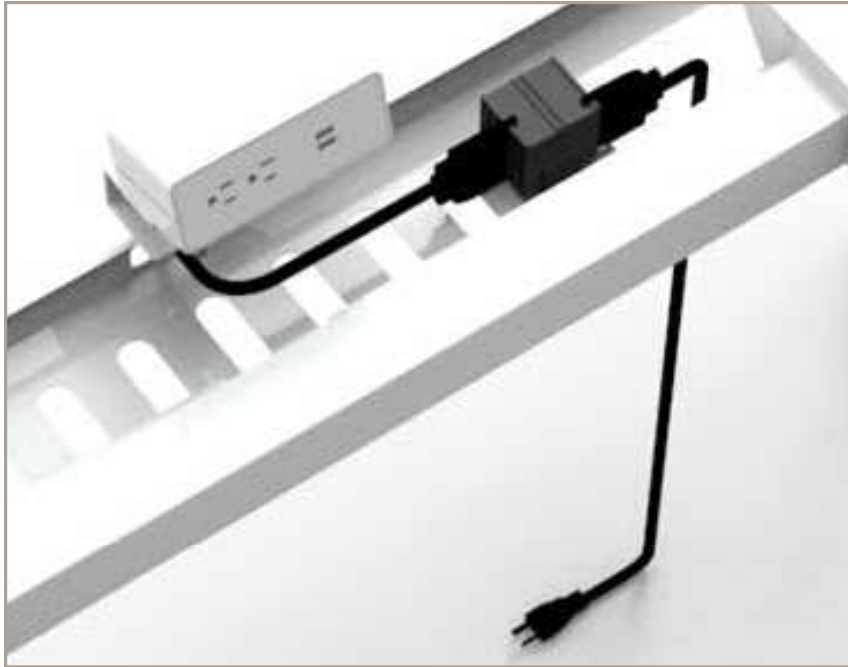

- Four-Circuit / Hardwire Power
- Dasiy-chainable
- Undersurface installation
- 48", 60" & 72" jumpers
- Desktop power modules with AC power or AC power + USB
- Up to 8-10 duplex outlets from a single feed, depending on local code

*Local electrician required for hardwire installation.*

*Confirm with your local building code offices for application in your area. This power system is UL Recognized (UR).*



6' Base Infeed • 4-Circuit / 8-Wire  
**CMB-8WBF2072 \$385**  
 Also Available:  
 90" Coupler for Infeed  
**CMB-8W20BFCON \$33**

Jumper Cables  
 4-Circuit / 8-Wire, Block-to-Block  
**CMB-8W48 48" Wide \$285**  
**CMB-8W60 60" Wide \$320**  
**CMB-8W72 72" Wide \$355**



Mounting Clip for Jumper Cables  
**CMB-503BK \$5**



Power Connecting Block  
 6 Slots  
**CMB-JBK8W \$70**



Mounting Clip for Power Block  
**CMB-508BK \$5**



Desktop Power Modules  
 White **\$210**  
**CMB-PWR509A-WH**  
**CMB-PWR509B-WH**  
**CMB-PWR509C-WH**  
**CMB-PWR509D-WH**



Duplex Power + (2) USB Module  
 White **\$425**  
**CMB-USBPWR509A-WH**  
**CMB-USBPWR509B-WH**  
**CMB-USBPWR509C-WH**  
**CMB-USBPWR509D-WH**



End Cap for Power Block  
 1 Slot  
**CMB-JBKJUMPERCAP \$4**

# Systems

## MADE-TO-ORDER



### Need additional options?

Our East Coast team can fabricate your panels in an extensive selection of panel fabrics as part of the **Systems MADE-TO-ORDER** program. Choose from the complete Burch Fabrics offering. Below left are (9) most-popular fabrics available at Grade 1 pricing. In addition to (4) stock worksurfaces, we offer 30+ worksurfaces at standard pricing; additional lead time may apply. Extensive selection of panel widths, heights, add-ons and much more.

### Worksurfaces

choose from  
**30+ MORE**  
standard  
worksurfaces



**URB** Urban Walnut



**SGW** Slate Grey

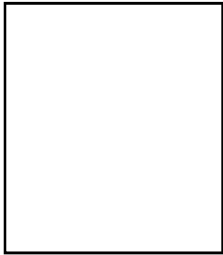

**WHT** White



**NAS** Natty Ash



**PCW** Park City

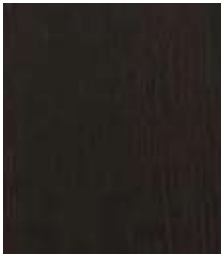

**ESP** Espresso

### grade 1 fabrics

many  
**MORE**  
fabrics  
available

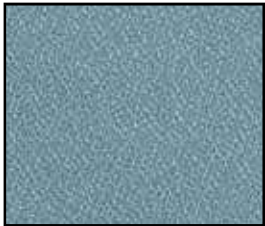

**15-06D** Cascade Blue



**15-17D** Winter Birch Taupe



**15-106D** Dove Grey



**19-71A** Nature Valleys



**19-85** Marseille



**24-13** Donnelly

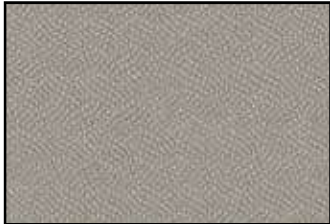

**24-18** Saran

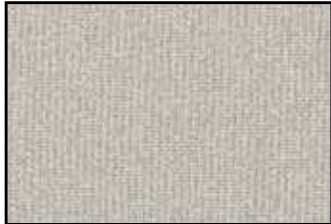

**YD-19-31** Meadows Drift



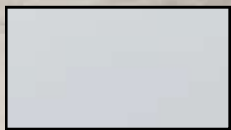

**SV** Silver



**WH** White

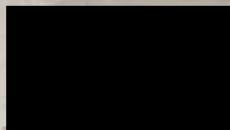

**BU** Black



**HF** Innertone Light

**Finishes**  
*Flush Base*

**Finishes**  
*Enhanced Base*

**MT** Medium Tone

**HF** Innertone Light

**BU** Burnt Umber

